

®



WESMARC
DOORS

LOOK BOOK AUG 2023

OPEN. ®
TOMORROW



wesmarcdoors.com

Doorways divide and connect worlds.
They form both the first and last impression.
They are quiet in their presence, and yet speak
volumes about the space they secure.
They give you a sense of safety when you enter and
a sense of reassurance when you are out.
They offer a glimpse of life as it could be, and
also of how far a journey it's been.

Doors are the quiet chroniclers of life,
and every time you step through a door,
you pick up a story where you left off.

So, we believe that every time you open a door, you

OPEN. [®]
TOMORROW





YOU DESERVE THE BEST, SO WE MAKE THE BEST.

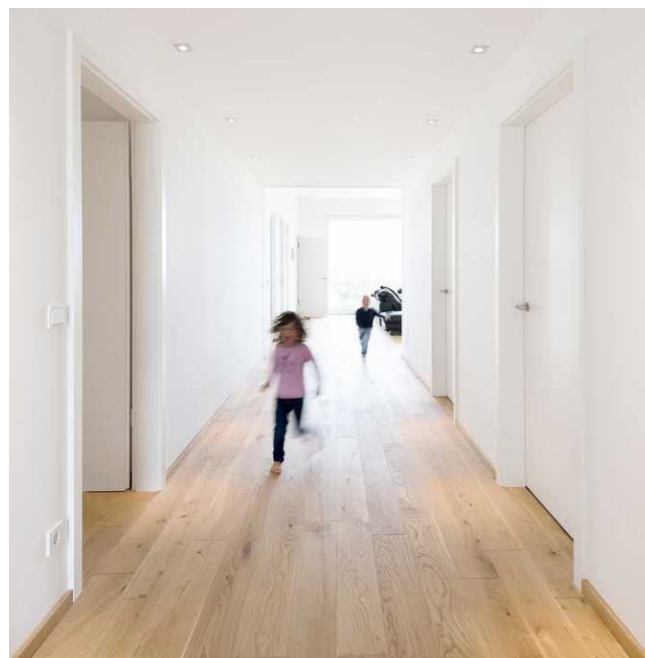

- Wesmarc Story 01
- Why WESMARC 07
- Expertise Installed 09
- Science Inside Simple Outside 11
- Enter WESMARC 13
- WESMARC Delight Studio 16
- Wood Entrance (Premium) 19
- Wood Entrance (Optimum) 23
- Wood Interior (Premium) 27
- Wood Interior (Optimum) 31
- Full Glass Door Interior 37
- Engineered Wood Frames 43
- Elegant Hardware 46
- Smart Accessories 50
- Dimensions 51
- Tolerances 52
- WESMARC is different from the rest 54
- Design Inspiration 55
- Material Palette 57
- Installation Made Easy 66

DOORS OF TOMORROW, FOR TODAY.

We create intelligent doors that work as well as they look. Because, we think that doors should not only bring your vision to life with a vibrant dash of colour or a minimal touch of class, but also enhance your everyday experiences.

So, with every door, we endeavour to make homes more intimate, office spaces quieter and public spaces more utilitarian. All while working perfectly time and again.



There is a belief which lies at the core of every WESMARC door: that every door should be safe and durable, work smartly and enhance the aesthetics of the space.



CPL Veneer Dark Oak / Door model A.1

A deep understanding of Indian sensibilities and day-to-day life and a thorough knowledge of the best in European engineering drives everything we create.



LOOKS SOPHISTICATED. FEELS INTELLIGENT.

Yes, our doors are beautiful. However, they go beyond just their appearance, because we understand what is important to you. Your space reflects memories, passions and the security of all that you hold dear. So, we help you choose the full door (door, frame and hardware) that is best suited for you. Which is why, we pay attention to the tiniest of details, and ensure the very best design, safety and durability in every single door.



DESIGN

WESMARC designs come from an appreciation for global trends and contemporary Indian styles. But at their core, our doors are designed to do one thing: to make life easier.

Through a state-of-the-art manufacturing process, and a watchful eye for the best materials, we've created a wide range of doors that is consistently world-class, with no compromise, even at scale. Furthermore, our doorsets can be installed with 2 hands and in just 30 minutes.

DURABILITY

Ever counted the number of times you open and close your door? Well, we have! To make our doors future proof, once the materials have met our standards, we comprehensively test every individual component and then the assembled full door, both mechanically and environmentally. We make sure that every WESMARC door is engineered to withstand the vast differences in usage patterns and environmental conditions, just so it feels like the first time, every time you open the door.



SAFETY

All of our doors are designed intelligently to maximise the safety of the space it encloses, because your safety is important to us. So important, that we make doors that are fire retardant, acoustically insulated or even reinforced with metal sheets. Moreover, every component is crafted to be easy-to-use, but tough to misuse. And we make all of this available to you at a simple half turn of the key. All to make sure that you always have the peace of mind you deserve, on either side of the door.



THE BEST OF THE WORLD, CRAFTED FOR INDIA.

4+ Decades of experience in the Indian construction space and a constant thirst for innovation led us to realize that the market needs a smarter solution when it comes to doors, frames & hardware.

So with the aim of shifting the paradigm, we surveyed technologies across the world, and identified the best of European practices. With this as a starting point, we invested over 4 years' worth of effort to develop our own range of products, re-engineered and attested to withstand the vast differences in usage patterns and environmental conditions across our country.



WESMARC STORY

200000 sq. ft

India's most Modern & Largest Door and Frame manufacturing.

4000+ SKUs

Product ranges across wood, engineered and glass.

47+ years of expertise

Across manufacturing, nationwide distribution and creating a leading brand in the Indian building industry.

LEGACY

WESMARC is the continuing legacy of a 3rd generation Indian entrepreneurial family that has a distinct track record for pioneering solutions, disrupting markets and climbing to a position of leadership since 1975.

Behind all of this success, however, is a simple ethos: a thorough understanding of the needs of the customer, a commitment to inculcate the very best practices, an uncompromising passion to execute an elegant solution and ultimately, to elevate the entire ecosystem.



Our high-tech, automated manufacturing unit at Bengaluru.

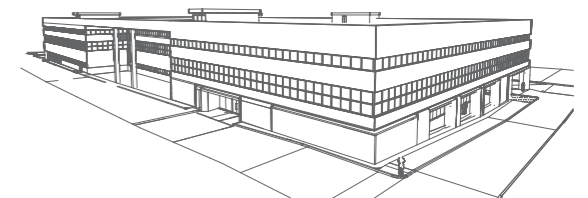

At WESMARC, we don't just make a better product, but we strive to achieve a holistically better way of doing things: from selecting the right full door (door, frame & hardware), to its installation and finally to its everyday use!

We've also made the process of choosing the right full door simple and transparent, because we intend to make life easier, not only by creating doors that are easy to install and use, but also by bringing in simplicity and transparency to the entire process.

WESMARC WALL WRAP ADJUSTABLE FRAME

Eng. wood wall wrap frame :Unique solution on the market wrapping the entire thickness of the wall ranging from 80mm up to 280mm thickness of the wall and comes pre-fitted with a co-extruded acoustic seal within the jamb groove.

Using our telescopic adjustable architraves, each frame size can be further adjusted by up to +20 mm on the thickness of the wall. Architraves are seamlessly joined at 45 degree & are 60 mm wide & 12mm thick. A high level of detail that also adds to the stability of the frame. Furthermore, they are finished with matching CPL veneers that give the impression of the perfectly finished frame creating a PORTAL look.

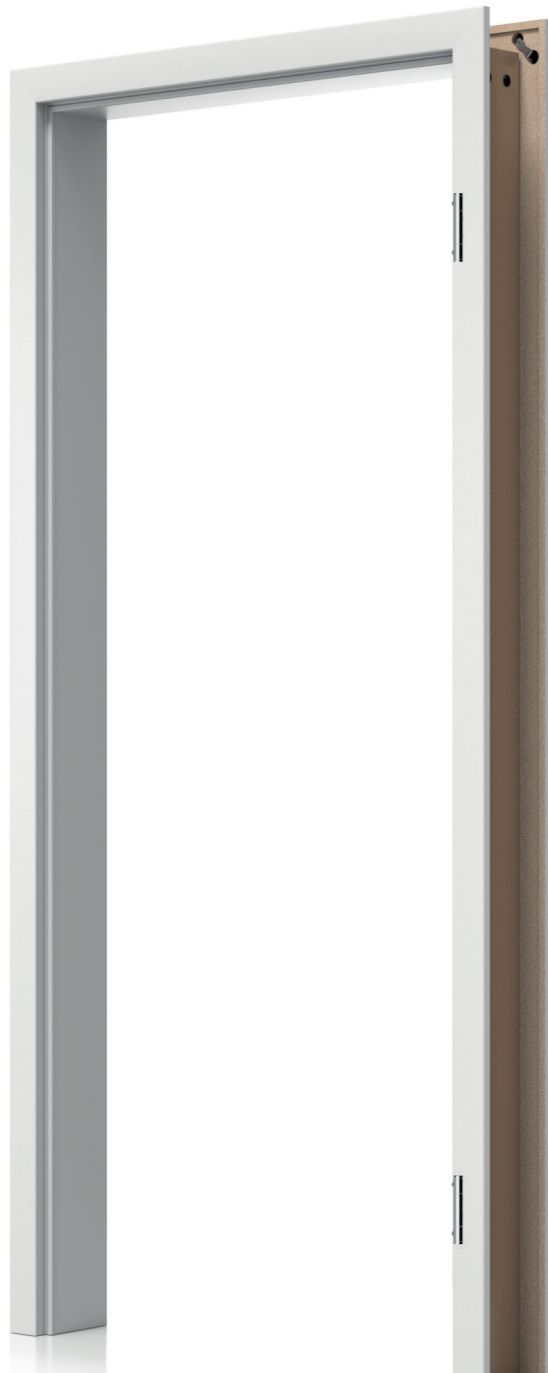

WESMARC FRAME

- Wraps the whole thickness of the wall.
- Door leaf is larger.
- More daylight compared to block frame.
- Allows for high wall tolerances on height (+Any mm/-50mm), width (+30mm/-50mm) & thickness (+20mm/-0mm).



TRADITIONAL/TYPICAL BLOCK FRAME

- Sits within the thickness of the wall.
- Door leaf is smaller.
- Less daylight compared to WESMARC frame.
- Allows for minimum wall tolerances, which will require additional work during installation.

WESMARC REBATED DOOR

Eng. wood rebated doors: Another unique solution on the market is rebated doors (Profiled edges) which add to the modern design of door leaves. This intelligent solution further aids in barricading dust, light, a/c losses & improves acoustic insulation between the rooms. To improve mechanical stability & durability against moisture, our doors are PVC edge banded using PUR glue on all the 4 leading edges.

The rebated profile also allows for easy adjustments, in both width (+/- 2mm) & height (+/- 2mm) between the door and frame to get the perfect & seamless installation, everytime.



WESMARC DOOR

- Rebated doors of thickness 42mm & 45mm.
- Modern design, no gaps with frame, Increasing acoustic insulation.
- Barricades dust, light and a/c losses.
- Opens the door to 180° and easily adjustable in 3D.

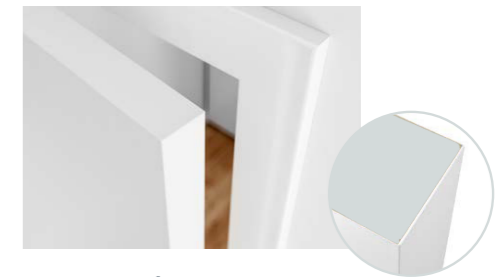

STRAIGHT/FLAT DOOR

- Typical door thickness 32/35mm.
- Old design, visible gaps with lesser acoustic insulation.
- Does not barricade dust, light and a/c losses.
- 3D adjustments not possible using traditional leaf/butt hinges used on straight edge doors.

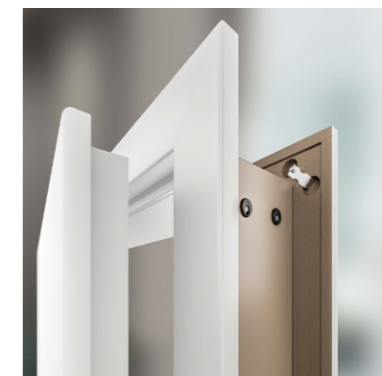

EXPERTISE INSTALLED

We engineer and create doors that are intuitive, so they're both easy to install and also ensure an effortless experience, every day.

DESIGN



WALL WRAP ADJUSTABLE FRAME

Create the **PORTAL** look.

- Wraps the full thickness of the wall.
- Integrated acoustic seal
- Wraps from 80mm to 280mm.
- Adjustable tolerance up to 20 mm.



REBATED DOORS

What happens inside, stays inside.

- Barricades dust, light and a/c losses.
- Increased acoustic insulation.
- Modern design, no gaps.

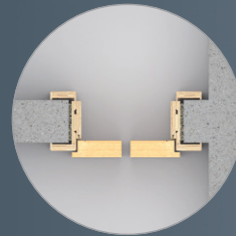

EASE OF INSTALLATION

Simply installed by 2 hands in 60 min.

- Clean installation, no dust, no sound.
- No resizing, polishing or finishing.
- No damage to finished rooms.



CPL VENEERS

Creating the first impression.

- High resistance & durability to scratches.
- Looks and feels like natural veneer.
- No colour variations, no maintenance.

SAFETY



2 ALUMINIUM SHEETS INSIDE

Stands the test of time.

- Reinforced construction.
- Provides additional strength & durability.
- Provides additional insulation.



REINFORCED LOCKS & STRIKER PLATES

Easy to close. Impossible to pick.

- Multi locking Security bolts .
- Reinforced rounded striker plates.
- EN rated Mortise lock & Cylinder.
- Perfectly flush fitted. No protruding elements.

DURABILITY



HINGES

The strong backbone.

- Door ingeniously just hangs on.
- Modern and sleek design. Soft closes the door with ease.
- Opens the door to 180°.
- Easily adjustable in 3D.



PUR ADHESIVE

We think of the little things, for you.

- High resistance to moisture & varying weather conditions.
- Excellent low & high temperature performance.
- Adequately applied across the entire Door & Frame construction.



EXPERTISE INSTALLED



Full Door : Door leaf, Frame (Jamb + Architraves), Hardwares, Accessories & Installation parts

SCIENCE INSIDE SIMPLE OUTSIDE

WESMARC is your one-stop-shop for a full door (door, frame and hardwares). The design of our doors brings simplicity and transparency to your decision-making process.

Plug and Play: Every part of a WESMARC door, from the door and frame, right down to the smallest of components is engineered for ease of installation. All the elements are packaged carefully and are ready to install, thus a full door can then be easily installed with just 2 hands and in 30 minutes. No Dust. No Noise. No Damage.

1 Application & Material



Start by identifying where the door is intended to be used & which construction type you prefer or otherwise require. Wesmarc doors are best suited for residences, offices, hotels, hospitals and other commercial spaces, as entrance or interior doorways, in spaces such as bedrooms, bathrooms and others. We build our doors with wood / engineered materials for its intended performance.

2 Dimension & Orientation



Note the height, width and thickness of the clear, finished wall opening where the door is to be installed. Also, determine which way the door should open, and choose a left or right door accordingly.

3 Design & Finish



The easiest step of them all. Simply choose the design or model of the door you want and the CPL veneer finish for the door and frame individually.



Experience unrivaled reliability and elegance with our Rebated Doors featuring adjustable frame technology now in India. Embraced by prestigious buildings in Dubai, Germany, and Europe, this innovation sets a new standard for excellence and ensures top-notch quality worldwide.

German Engineered. Bharat Made



CPL Veneer Stained Walnut



CPL Veneer White Ash



CPL Veneer Dark Oak



CPL Veneer Natural Walnut



CPL Veneer Natural Eucalyptus



CPL Veneer Natural Oak

ENTER WESMARC

WESMARC PRODUCT ARCHITECTURE

■ WOOD

ENTRANCE (PREMIUM)

Created to offer a high level of security at the entrances of apartments, villas, offices and other commercial spaces, this unique set of aluminium sandwiched premium entrance doors are aesthetically sophisticated and incredibly difficult to misuse.

Recommended Applications :
Apartments / Villas / Offices / Hotels / Commercial spaces.

ENTRANCE (OPTIMUM)

The closed body mortise lock and the security bolts give you a reassuring sense of security, while the modern designs of this effortlessly elegant line of doors gives you both a great first and last impression.

Recommended Applications :
Residences / Offices / Hotels / Commercial spaces.

INTERIOR (PREMIUM)

Built to offer you the quiet sense of calm that the bedroom, office or bathroom demands, these doors are highly secure and also acoustically insulated. Further, the minimal designs can give any space, a facelift.

Recommended Applications :
Apartments / Villas / Offices / Hotels / Commercial spaces.

INTERIOR (OPTIMUM)

Versatile, robust and efficient, these doors offer a broad range of applications. They're capable of handling the daily stresses of offices and homes alike. The look of this door can be further enhanced with glass inserts or wood panels.

Recommended Applications :
Bedroom / Bathroom/ Kitchen / Study / Lounge / Office / Pantry / Stores.

INTERIOR FULL GLASS

Glass Door is a way to bring more light to every room corner and create the bright and modern interior design. What's more? These doors are also designed to be a refreshing sight at the shop entry.

Recommended Applications :
Any interior spaces.

▲ ENGINEERED

FRAME

Wesmarc wall wrap adjustable frame offers superlative quality combined with it's Eng. construction which guarantees excellent dimensional stability and resistance to stress. The hybrid hinge bracket & lock plate reinforced into the jamb offer maximum durability and safety.

Recommended Applications :
Any entrance & interior spaces.

OUR DOORS ARE NEVER OUT OF PLACE

The design of our doors brings simplicity and transparency to your decision-making process.

Our doors are crafted to suit any space. So, identify where the door is intended to be used and which construction type you prefer, or otherwise require. Then, choose the design or model you want and the CPL veneer finish for the door and frame.

Our intricate, high-design elements showcase sophistication and modern design. A.1 is a timeless plain design, P.1/P.2 are models with wood filling panels, G.1/G.2 are our models with clear glass, C.1 adds a touch of drama with clear glass & with wood filling panel and F.1 the complete full glass door is the star amongst doors: they open up rooms and perspectives.

Entrance (Premium & Optimum)



Model A.1

Interior (Premium, Optimum & Universal)



Model A.1

Interior Full glass door



Model F.1

Interior (Optimum) + Model Doors



Model P.2



Model G.1



Model G.2



Model G.4



Model C.1

WESMARC DELIGHT STUDIOS

Introducing the new WESMARC Experience Centres in Bangalore, Mysore, Hyderabad, Vishakapatnam, Vijayawada, Chennai, and Coimbatore.

Discover complete doors, frames, and hardware all in one place, making door and frame selection easier than ever. See and believe the possibilities firsthand at our state-of-the-art display galleries strategically located across these cities.





WOODEN DOORS

WOOD ENTRANCE (PREMIUM)

When every space is unique, why should the entrances look the same? Doors welcome you home after a long day at the office, or even welcome you back to the office the following day: they are the cover to your story.

And it is for this reason that we have created a beautiful set of entrance doors, but while these doors are easy on the eye, rest assured, they're incredibly difficult to misuse. In fact, they offer you the kind of superior security that only an Aluminium sandwiched door can promise.

What's more? They can be used in apartments, villas, offices, hotels or indeed, any space that demands a high level of security at the entrance.

Moreover, while the doors promise to stand resolute, they are designed to feel light when opened or closed. They are also finished with a high-quality cpl veneer, so you can be sure that you receive the same welcome every time.

RECOMMENDED APPLICATIONS :

APARTMENTS / VILLAS / OFFICES / HOTELS /
COMMERCIAL SPACES.



CPL Veneer Stained walnut / Door model A.1

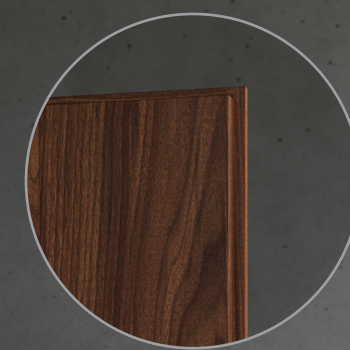

45mm Door with 5.5mm Deck:
Reinforced construction with modern & sturdy profile also enhancing sound insulation.

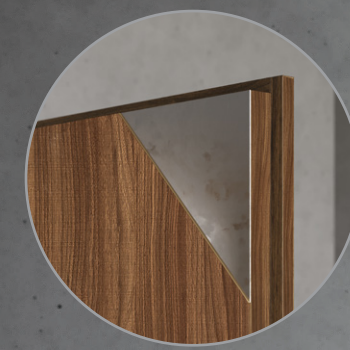

Aluminium Layer:
Reinforced construction providing additional strength, stability & durability.



2nd Upper Lock:
The additional lock set with the main lock guarantees security for entrances.



ENTRANCE (PREMIUM)
WOOD

PRODUCT INFO

Premium solutions for entrances. Its reinforced construction meets the highest requirements of safety, durability and comfort in everyday use.

The doors are additionally sandwiched with 2 layers of AL, which significantly improves its functional and mechanical properties over a longer-term. Additionally, by adding a threshold, this assembly then achieves a sound insulation of +30dB. Externally, The doors are available as a plain design.

DIMENSIONS

Finished Wall Opening Sizes (mm)

Height	Width	Wall Thickness
2350	1100	180 - 200
		200 - 220
	1200	220 - 240
		240 - 260
		260 - 280

For wall thickness Wesmarc has the standard sizes mentioned in the table above, however upon request we can make frames for all wall thickness sizes from 80mm to 280mm in steps of 20mm.

STANDARD OFFER INCLUDES

- 45mm thick door leaf s/w with 2 AL sheets on 5.5mm HDF decks which are finished with CPL veneer on both sides
- These doors are made with a solid core infill.
- Rebated door profile finished with all 4 sides PVC edge band.
- Full wall thickness wrap around adjustable frames finished with CPL veneer of your choice.
- Integrated perimeter seals and 60mm wide architraves in matching CPL veneer.
- #3 or 4 reinforced 3-element hinges based on the size of the wall opening.
- #2 mortice locks with a rectangular dead bolt adapted for cylindrical door locks.
- #2 cylindrical locks with key-knob configuration & 5 sets of keys each.
- Steel reinforced striker plates for additional safety.
- #3 additional security locking bolts on the opposite side of the door lock.

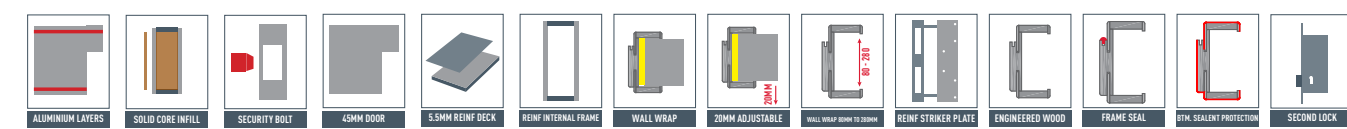

A TOUCH OF CLASS THAT FITS EVERY SPACE

Double doors, a design feature characterized by two adjacent door panels that swing open from the center, offer an elegant and practical solution for entryways. These doors not only create a striking visual impact but also provide enhanced functionality, allowing for a wider opening to accommodate large gatherings, furniture, or facilitate smooth movement between indoor and outdoor spaces.

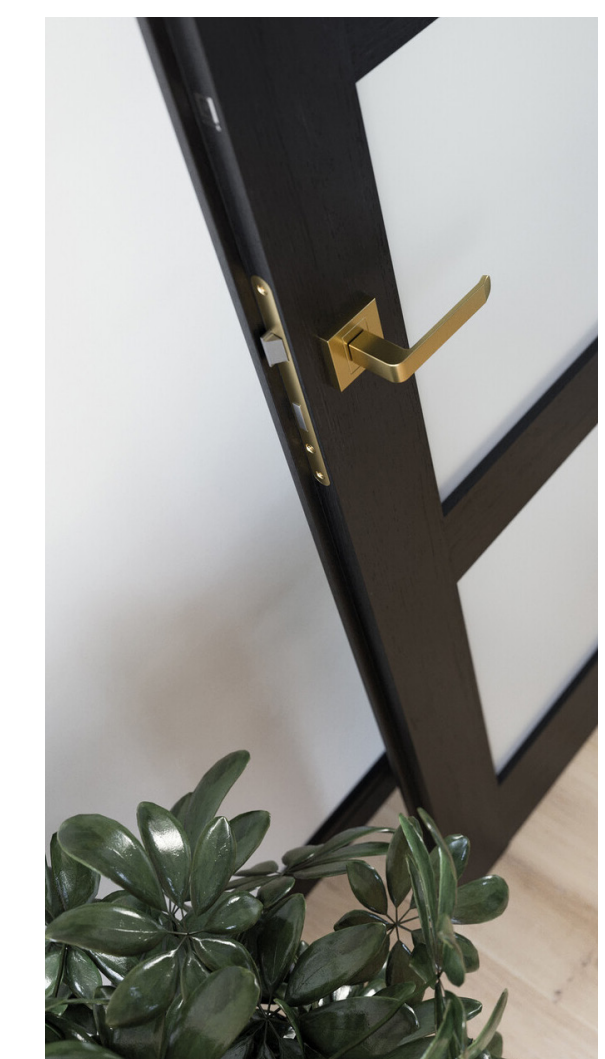

ENTRANCE (PREMIUM)
WOOD

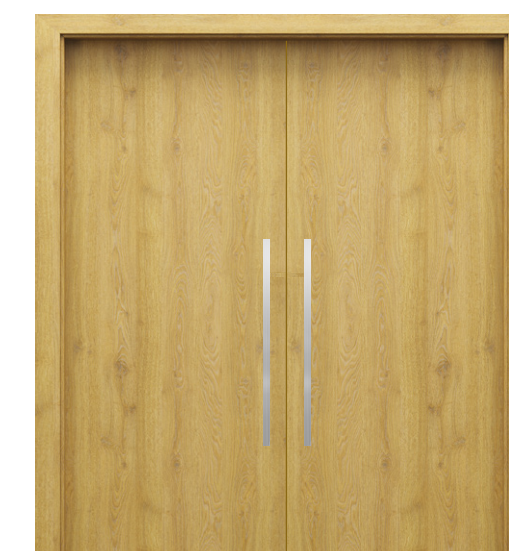

Equal Double Door, Model A.1



Equal Double Door, Model G.4



Offset Double Door, Model A.1

WOOD ENTRANCE (OPTIMUM)

The entrance door is a reflection of your status. And so, it doesn't just require a pleasing design, but also a high level of security and durability. Which is why, we build this door with a tubular core infill and is additionally reinforced with 3 security bolts.

Further, these doors are designed to play a role in the styling of your home. Because, in addition to a good first impression, the entrance door is also responsible for a good last impression. After all, the door is the last thing you will see and touch before leaving.

RECOMMENDED APPLICATIONS :

RESIDENCES / OFFICES / HOTELS / COMMERCIAL SPACES.



WOOD
ENTRANCE (OPTIMUM)



#3 security locking bolts :
Intelligent solution to additionally secure against forced unauthorized opening.



Reinforced Hinges :
Modern & sleek design providing increased stability & durability. Door ingeniously just hangs on & also opens a full 180°.



Tubular Core :
Reinforced construction providing additional strength & stability.



WOOD ENTRANCE (IOPTIMUM)

PRODUCT INFO

This is our offer for entrance doors to homes, offices, commercial spaces, hotels among others. The door leaf is 42mm thick and is available as a plain design externally finished with CPL veneer of your choice.

DIMENSIONS

Finished Wall Opening Sizes (mm)

Height	Width	Wall Thickness
2350	1100	80 - 100
		120 - 140
		140 - 160
		160 - 180
		180 - 200
	1200	200 - 220
		220 - 240
		240 - 260
		260 - 280

Finished Wall Opening Sizes (mm)

Height	Width	Wall Thickness
2100	1100	80 - 100
		120 - 140
		140 - 160
		160 - 180
		180 - 200
		200 - 220
		220 - 240
		240 - 260
		260 - 280

For wall thickness Wesmarc has the standard sizes mentioned in the table above, however upon request we can make frames for all wall thickness sizes from 80mm to 280mm in steps of 20mm.

STANDARD OFFER INCLUDES

- 42mm thick door leaf on 4mm HDF decks which are finished with CPL veneer on both sides
- These doors are made with a Tubular core core infill.
- Rebated door profile finished with all 4 sides PVC edge band.
- Full wall thickness wrap around adjustable frames finished with CPL veneer of your choice.
- Integrated perimeter seals and 60mm wide architraves in matching CPL veneer.
- #2, 3 or 4 reinforced 3-element hinges based on the size of the wall opening.
- #1 mortice lock with a rectangular deadbolt adapted for cylindrical door lock.
- #1 cylindrical lock with key-knob configuration & 5 sets of keys each.
- Flush fitted and rounded Steel reinforced striker plates for additional safety.
- #3 additional security locking bolts on the opposite side of the door lock.

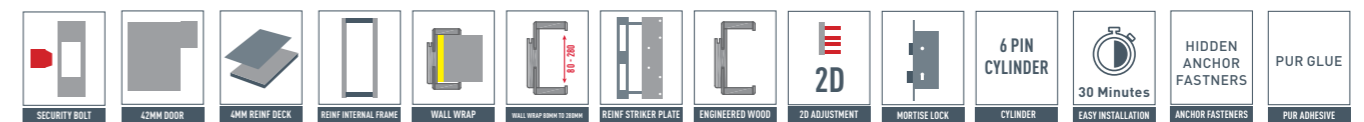

WOOD INTERIOR (PREMIUM)

Regardless of the hours you spend at home, there is always a need for reflecting on the day that has passed or, to regroup for the day to come. Be it at your table in the study, or by the bedside at the bedroom, or maybe even while making yourself a cup of tea in the kitchen.

And of course, this calls for the privacy and silence. So, be sure to make this space yours by separating it from the open areas of the home with a full door. You can even play up the comfort by installing an acoustically insulated wooden door. Further, matching the colours of the door with your furniture will bring a harmony to the space, and the presence of natural feeling engineered wood makes it perfect for a cosy night in. Should you feel the need to personalize the room even further with bold colours, feel free. Because you will surely find a door that fits your imagination.

RECOMMENDED APPLICATIONS :

APARTMENTS / VILLAS / OFFICES / HOTELS /
COMMERCIAL SPACES.



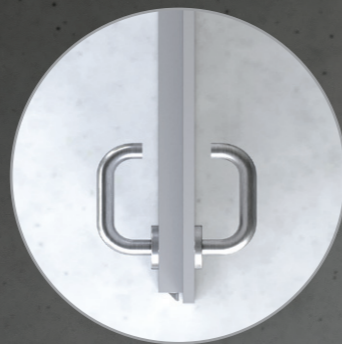

45mm Door with 5.5mm Deck:
Reinforced construction with modern & sturdy profile also enhancing sound insulation.

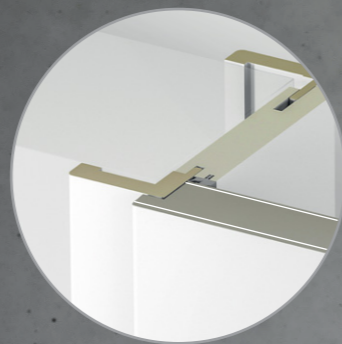

Aluminium Layer :
Reinforced construction providing additional strength, stability & durability.



PUR Adhesive :
High resistance to moisture & varying weather conditions. Adequately applied across the entire Door & Frame construction.



WOOD INTERIOR (PREMIUM)

PRODUCT INFO

Premium solutions for interiors. Its reinforced construction meets the highest requirements of safety, durability and comfort in everyday use. The doors are additionally sandwiched with 2 layers of AL, which significantly improves its functional and mechanical properties over a longer-term. Additionally, by adding a threshold, this assembly then achieves a sound insulation of +30dB. Externally, the doors are available as a plain design with CPL veneer of your choice.

DIMENSIONS

Finished Wall Opening Sizes (mm)

Height	Width	Wall Thickness
2350	900	80 - 100
		120 - 140
		140 - 160
		160 - 180
		180 - 200
		200 - 220
		220 - 240
		240 - 260
260 - 280		

Finished Wall Opening Sizes (mm)

Height	Width	Wall Thickness
2350	1000	80 - 100
		120 - 140
		140 - 160
		160 - 180
		180 - 200
		200 - 220
		220 - 240
		240 - 260
260 - 280		

For wall thickness Wesmarc has the standard sizes mentioned in the table above, however upon request we can make frames for all wall thickness sizes from 80mm to 280mm in steps of 20mm.

STANDARD OFFER INCLUDES

- 45mm thick door leaf s/w with 2 AL sheets on 5.5mm HDF decks which are finished with CPL veneer on both sides.
- These doors are made with a tubular core infill.
- Rebated door profile finished with all 4 sides PVC edge band.
- Full wall thickness wrap around adjustable frames finished with CPL veneer of your choice.
- Integrated perimeter seals and 60mm wide architraves in matching CPL veneer.
- #2 or 3 reinforced 2-element or 3-element hinges based on the size of the wall opening.
- #1 mortice lock with a rectangular deadbolt adapted for cylindrical door lock.
- #1 cylindrical lock with key-knob configuration & 5 sets of keys each.
- Flush fitted and rounded striker plates.

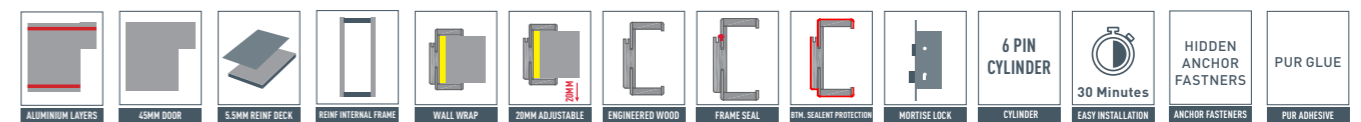

WOOD INTERIOR (OPTIMUM)

Versatile, robust and efficient, these interior doors offer a broad range of applications in homes, offices or other commercial spaces.

They can reflect the energy of your little ones with a pop of colour and can also add a minimal presence to the study or office space, without any compromise to its functionality, reliability, or indeed, its look. Whatever the purpose may be, you will surely find the door that represents you while working perfectly time and again.

To us, a bathroom door has two major characteristics. It should offer you a great deal of privacy, but should also possess a certain finesse in its detailing.

After all, it is where we go to get ready for the day, every morning. So, this line of doors comes with the option of having a beautifully framed glass insert, and also possesses a two-way emergency lock, just to make sure that no nightmares ever breach your self-care routine.

RECOMMENDED APPLICATIONS :

BEDROOM / KITCHEN / STUDY / LOUNGE /
OFFICE / BATHROOM / PANTRY / STORES.



CPL Veneer Dark Oak / Door model A.1

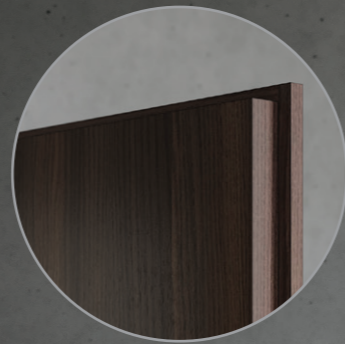

42mm Door :
Unique on the market, 42mm thick door leaves provide for a greater stiffness & a stronger barrier to the outside.

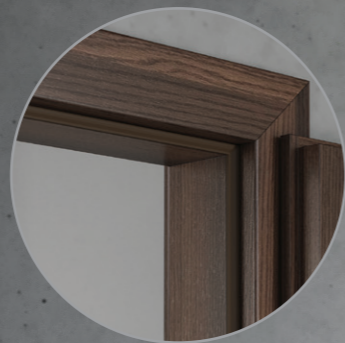

Rebated profile & 4 side Edge band :
Offers incomparably higher resistance and door edge protection than veneer or paint, yet still gives the impression of wood.



Reinforced internal frame :
75mm Stiles & Rails are made of engineered wood which give structural stability and reinforcement for hardware installation.



Model A.1 Model P.1 Model P.2 Model G.1 Model G.2 Model C.1

WOOD INTERIOR (OPTIMUM)

PRODUCT INFO

Comfort and privacy is of prime importance in bedrooms and other interior applications such as kitchens, study, home office, lounges, bathrooms, pantries, stores and our door sets are designed to fulfil just this need. Our sophisticated modern designs are available in plain, Glass, Wood or its combination panel models.

DIMENSIONS

Finished Wall Opening Sizes (mm)

Height	Width	Wall Thickness
2350	750	80 - 100
		120 - 140
		140 - 160
	900	160 - 180
		180 - 200
		200 - 220
	1000	220 - 240
		240 - 260
		260 - 280

Finished Wall Opening Sizes (mm)

Height	Width	Wall Thickness
2100	750	80 - 100
		120 - 140
		140 - 160
	900	160 - 180
		180 - 200
		200 - 220
	1000	220 - 240
		240 - 260
		260 - 280

For wall thickness Wesmarc has the standard sizes mentioned in the table above, however upon request we can make frames for all wall thickness sizes from 80mm to 280mm in steps of 20mm.

STANDARD OFFER INCLUDES

- 42mm thick door leaf with 4mm HDF decks which are finished with CPL veneer on both sides.
- These doors are made with a tubular core infill.
- Rebated door profile finished with all 4 sides PVC edge band.
- Full wall thickness wrap around adjustable frames finished with CPL veneer of your choice.
- Integrated perimeter seals and 60mm wide architraves in matching CPL veneer.
- #2 or 3 reinforced 2-element or 3-element hinges based on the size of the wall opening.
- #1 mortice lock with a rectangular deadbolt adapted for cylindrical door lock.
- #1 cylindrical lock with key-knob or coin-knob (bathrooms) configuration & 5 sets of keys each.
- Flush fitted and rounded striker plates.





 **ENGINEERED DOORS**

Full Clear glass, Door model F1

INTERIOR FULL GLASS DOOR

Homes, offices, and public spaces alike could call for exceptional requirements. While they should be welcoming to people, full Glass Door is a way to bring more light to every room corner and create the bright and modern interior design.

Dare to make a statement with your full glass door in terms of living ambiance. Frames give shape to your fantasies. Because after all, they are the home to treasured memories, friends, and family. The frame and the related hardware are built for visually increasing home interiors or office spaces and giving the impression of lightness. A wide range of design possibilities makes these specialist doors quite an attractive proposition.

RECOMMENDED APPLICATIONS :

PUBLIC SPACES / RESIDENCES / OFFICES / SHOP FRONTS



welcome: (verb)*
to greet the arrival of a person with pleasure and courtesy.

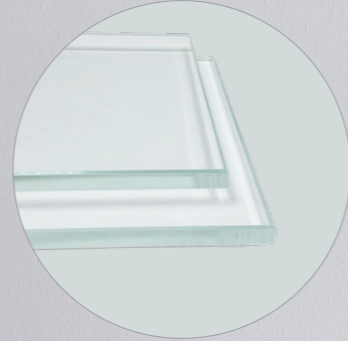

10mm Glass :
Toughened safety glass (TSG).
Durable & less susceptible to scratches, wear and tear.



Reinforced Hinges :
Modern & sleek design providing increased stability & durability.
Door ingeniously just hangs on & also opens a full 180.



Interchangeable Frame :
The same frame is interchangeable between full glass doors & our interior wood doors.



PRODUCT INFO

The full Glass Door leaf version in the WESMARC collection comes with 3D adjustable, 2 Element hinges : designed to be visible once the door is closed, for beautifully seamless results, even with the door open, allowing it to be opened a full 180 degree. The door frame is warped onto the wall and ceiling finished with CPL veneer.

DIMENSIONS

Finished Wall Opening Sizes (mm)

Height	Width	Wall Thickness
2350	750	80 - 100
		120 - 140
		140 - 160
	900	160 - 180
		180 - 200
		200 - 220
	1000	220 - 240
		240 - 260
		260 - 280

Finished Wall Opening Sizes (mm)

Height	Width	Wall Thickness
2100	750	80 - 100
		120 - 140
		140 - 160
	900	160 - 180
		180 - 200
		200 - 220
	1000	220 - 240
		240 - 260
		260 - 280

For wall thickness Wesmarc has the standard sizes mentioned in the table above, however upon request we can make frames for all wall thickness sizes from 80mm to 280mm in steps of 20mm.

STANDARD OFFER INCLUDES

- 10mm tempered glass completely clear, which can be additionally frosted for privacy with frosting stickers.
- Full wall thickness wrap around adjustable frames finished with CPL veneer.
- Integrated perimeter seals and 60mm wide architraves in matching CPL veneer.
- #2 or 3, reinforced 2-element glass door hinges.
- #1 All in one knob-key lock with deadbolt adapted for glass doors, and 3 sets of keys.

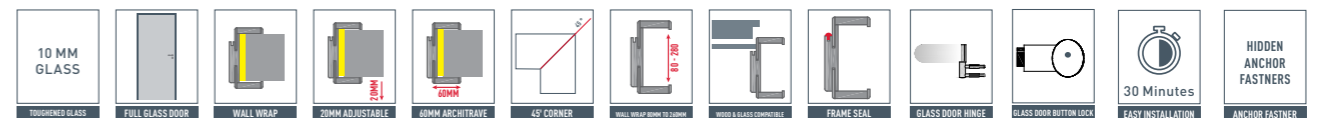



 **ENGINEERED FRAME**



Perimeter Frame seal :
High quality co-moulded & extruded seals ensures comfort of use by soft closing the door and improving acoustic insulation.



Architraves :
60 mm wide & 12mm thick architraves are finished with matching CPL veneers and give the impression of the perfectly finished frame.



Mitre frames at 45° :
Architraves are seamlessly joined at 45°. A high level of detail also adds to the stability of the frame.

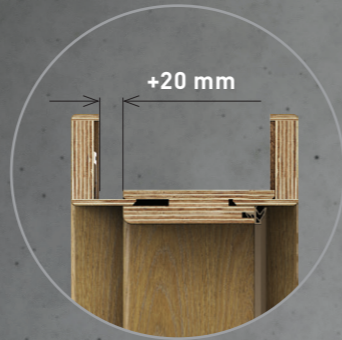

Eng. wood wall wrap frame :
Unique solution on the market wrapping the entire thickness of the wall. Can be adjusted up to 20 mm.



Striker plate :
Perfectly fitted without any protruding elements. Reinforced with steel plates & slots finished with stiff plastic end caps.



PUR Adhesive :
High resistance to moisture & varying weather conditions. Adequately applied across the entire Door & Frame construction.

PRODUCT INFO

Frames add all the detail and value to a well-designed interior. It's the little things that count. To compliment a high-design door, one needs an even more sophisticated and intelligent frame.

A well-designed frame covering the entire thickness of the wall, the possibility of adjustment up to 20mm and extremely easy and quick installation make our product unique in the market.

All our frames are integrated with a perimeter acoustic seal and are offered with 60mm wide architraves in matching CPL veneer to the main frame.

DIMENSIONS

Finished Wall thickness (mm)

Wall Thickness	Architraves
80-100	60
100 - 120 (Upon request)	60
120-140	60
140-160	60
160-180	60

Finished Wall thickness (mm)

Wall Thickness	Architraves
180-200	60
200-220	60
220-240	60
240-260	60
260-280	60

- Wesmarc makes two finished wall opening heights of 2100mm & 2350mm.

- Wesmarc makes five finished wall opening widths of 750mm, 900mm, 1000mm, 1100mm & 1200mm.

WALL WRAP ADJUSTABLE FRAME

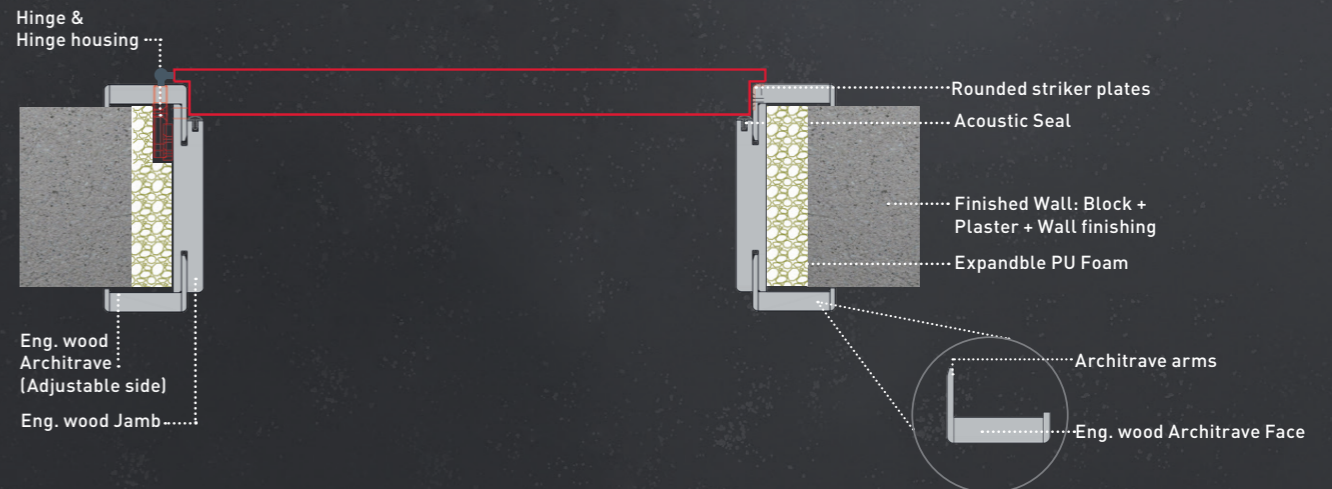



ELEGANT HARDWARES. EVERY DAY.

While we understand the importance of having elegant hardwares, it's about a lot more than outward appearance.

It is also about the inner peace you get from having a solid, secure metalware.

HINGES: Modern & Sleek design that allows for the door to ingeniously "hang on" the frame

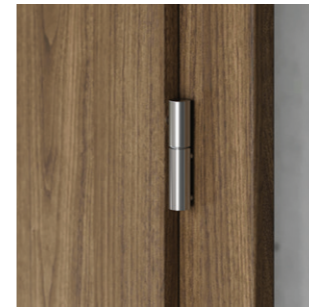

2 Element Hinge

2E Hinge

- Opens the door to 180°.
- Easily adjustable in 3D.
- Can add-on hinge caps.

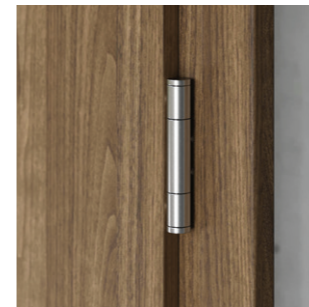

3 Element Hinge

3E Hinge

- More weight bearing capacity.
- Opens the door to 180°.
- Easily adjustable in 2D.
- Can add-on hinge caps.

SECURITY BOLTS: Intelligent solution to additionally secure against forced un-authorized opening



Security Bolts : #3 No.s

Security Bolt

- Multy locking Security bolts.
- Provides additional locking strength.
- Reinforced rounded striker plates.
- Perfectly flush fitted & no protruding elements.

HINGE BRACKETS: Allows for easy hinge mounting on the reverse side of the frame



2E/3E hinge mounted on bracket

Adjustable hinge bracket

- Compatible for both 2E & 3E hinge .
- 6 screws allows for sturdy installation .
- Reinforced nylon + GF body.

STRIKER PLATE: Sleek & perfectly flush fitted, no protruding elements



Reinforced rounded striker plate

Reinforced striker plate

- 1.5mm stainless steel round profile.
- Finished with stiff plastic end caps .
- Reinforced with 2mm thick steel plates.

MAIN LOCK: Easy to close & impossible to pick mortise locks with rounded face plates



EN rated heavy duty mortise lock

Mortise main lock

- Double throw dead-bolt 21mm.
- Round forend plate.
- Fully enclosed body.

2nd UPPER LOCK: Multi locking, guarantees additionally security for entrances

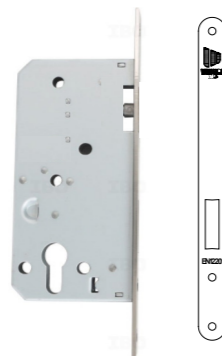

EN rated heavy duty mortise lock

Mortise 2nd lock

- Double throw dead-bolt 21mm.
- 10mm thick dead-bolt .
- High grade lock EN12209.

CYLINDER: Easy to use & that stand the test of time



6 pin security euro cylinder + 5 keys

Euro profile cylinder

- 5 computer cut ultra-security keys.
- Offset Euro Cylinder in full brass body with 6 pins.
- Cylinder Body : satin steel finish
- 200000 cycles Tested.

HANDLES: Beyond aesthetics, we grasp the essence of a refined touch.



Mortise lever handle

- SS 304, Solid casted handles .
- Matte/Gloss finish.
- 200,000 cycles tested.

FRAME ACOUSTIC SEAL: What happens inside, stays inside

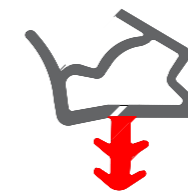

Co-extruded acoustic seal

Frame seal

- Soft closes the door with ease.
- Provides additional acoustic insulation.
- Barricades dust, light and A/C losses.

FRAME INSTALLATION HARDWARES (Included inside frame box)



Architrave clamp



Jamb connecting pins



Dowel



Anchor bracket

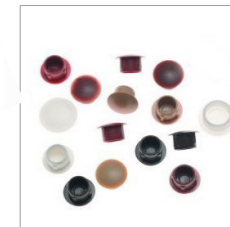

Closing cap

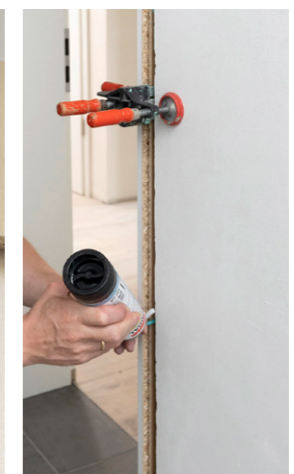

WE THINK OF THE LITTLE THINGS FOR YOU

ACCESSORIES

THRESHOLDS: Creating first impressions



STAINLESS STEEL THRESHOLD

- Durable, convenient and sleek low profile.
- Provides additional acoustic insulation.
- Integrated rubber seal.



WOOD THRESHOLD

- Enhances flooring transition with functional and aesthetic benefits.
- High quality engineered wood with matching CPL veneer.
- Integrated rubber seal.

WESMARC DOOR CLOSER: The strong backbone

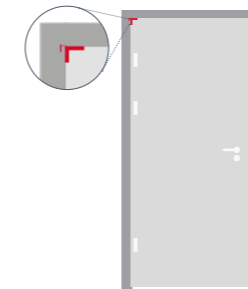

DIY: Do It Yourself door closer

- Install in under 1 minute & no tools.
- 3- Speed adjustable.
- Opens the door 90°.
- No drilling no damage to the door.

WESMARC ADDITIONAL ARCHITRAVE: Create the PORTAL look.



WOOD BEADING

- Decorative elements to your doors and frames.
- Visually appealing design.
- Color-matched CPL veneer beadings.

List Price per 1 Set= Rs 3100/-

WESMARC TOP PANEL WITH ARCHITRAVE: A glimpse of Beauty Above



TOP PANEL

- Enhances aesthetic appeal of the door.
- Offers a variety of customization options in terms of wood type, finish, and design.
- 60mm color matched architrave.

WESMARC TOP PANEL WITHOUT ARCHITRAVE: A peek of elegance from above



TOP FLAT PANEL

- Enhances the aesthetic appeal of a room.
- Provides a sleek and modern look
- Offers a smooth and flat surface.

List Price per 1 board (1220mm x 2440mm)= Rs 4500/-

DECORATIVE CAPS: The jewellery of Doors.



Hinge caps

- Decorative Aluminium caps Ø 15mm .
- Beautiful and long lasting appearance
- Available for 2-E and 3-E hinge.
- Scratch-resistant Coating.

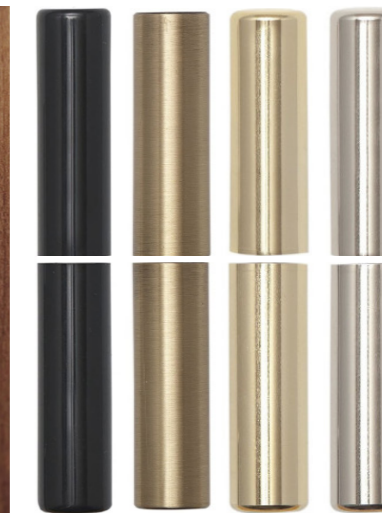

DIMENSIONS SINGLE DOOR

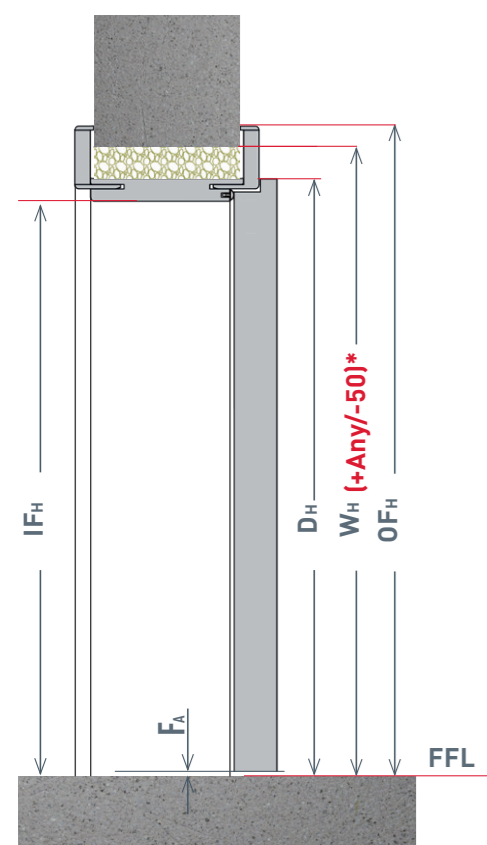
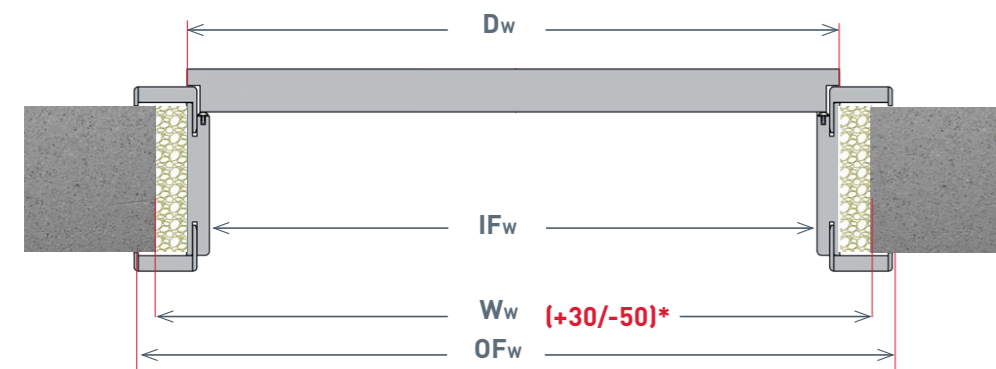

Legend

Sl No.	Description	Code
1	Height of Finished Wall Opening	WH
2	Width of Finished Wall Opening	Ww
3	Height of Door Leaf	DH
4	Width of Door Leaf	Dw
5	Height Inside Frame	IFH
6	Width Inside Frame	IFw
7	Height Outside Frame	OFH
8	Width Outside Frame	OFw
9	Door Thickness	DThk
10	Floor Allowances	FA

* Maximum & Minimum allowable wall tolerances with available wall extensions on both sides.

** Maximum & Minimum allowable wall tolerances without wall extension on 1 side.
Width (+30mm/-20mm)
Height (+Any/-0mm)

Finished Wall Opening Sizes (mm)

Sl No.	WH +Any / -50	Ww +30/-50	DH ± 3	Dw ± 2	IFH ± 3	IFw ± 2	OFH ± 3	OFw ± 2	DThk +0.5/-1	FA ± 1
1	2100	750	2043	680	2028	638	2100	782	42/45	6.5
2	2100	900	2043	830	2028	788	2100	932		
3	2100	1000	2043	930	2028	888	2100	1032		
4	2100	1100	2043	1030	2028	988	2100	1132		
5	2350	750	2293	680	2278	638	2350	782		
6	2350	900	2293	830	2278	788	2350	932		
7	2350	1000	2293	930	2278	888	2350	1032		
8	2350	1100	2293	1030	2278	988	2350	1132		
9	2350	1200	2293	1130	2278	1088	2350	1232		

DIMENSIONS DOUBLE DOOR

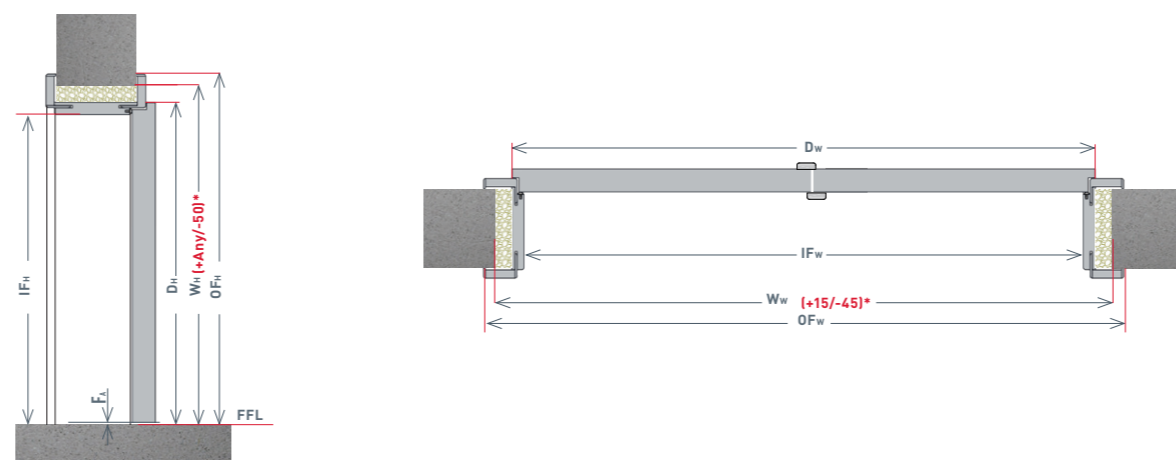

Finished Wall Opening Sizes (mm)

Sl No.	DDc +Any / -50	WH +15/-45	Ww	DDR	DH ± 3	Dw ± 2	IFH ± 3	IFw ± 2	OFH ± 3	OFw ± 2	DThk +0.5/-1	FA ± 1
1	900 + 900	2100	1750	1700-1765	2043	1666	2028	1624	2100	1768	42	6.5
2	1000 + 1000	2100	1950	1900-1965	2043	1866	2028	1824	2100	1968		
3	900 + 900	2350	1750	1700-1765	2293	1666	2278	1624	2100	1768		
4	1000 + 1000	2350	1950	1900-1965	2293	1866	2278	1824	2100	1968		

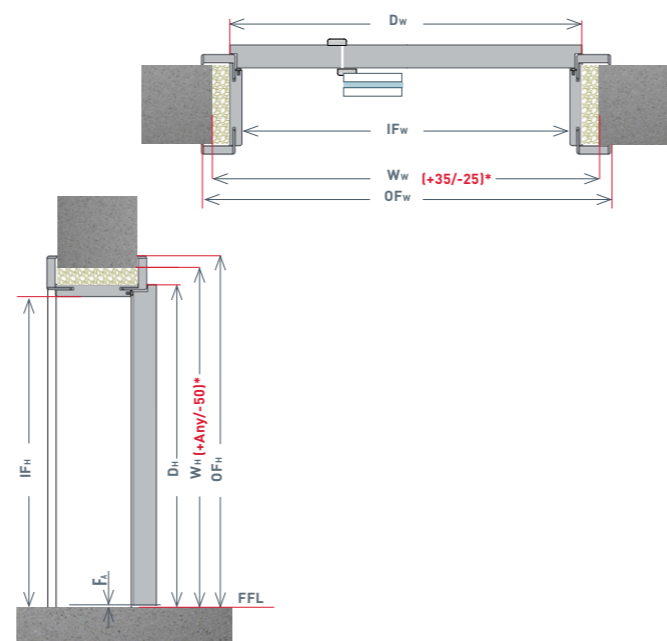

Legend









Sl No.	Description	Code
1	Double Door Combination	DDc
2	Height of Finished Wall Opening	WH
3	Width of Finished Wall Opening	Ww
4	Double Door Range	DDR
5	Double Door Leaf Height	DDH
6	Double Door Leaf Width	DDw
7	Height Inside Frame	IFH
8	Width Inside Frame	IFw
9	Height Outside Frame	OFH
10	Width Outside Frame	OFw
11	Door Thickness	DThk
12	Floor Allowances	FA

Finished Wall Opening Sizes (mm)





Sl No.	DDc +Any / -50	WH +35/-25	Ww	DDR	DH ± 3	Dw ± 2	IFH ± 3	IFw ± 2	OFH ± 3	OFw ± 2	DThk +0.5/-1	FA ± 1
1	900 + 450	2100	1350	1326-1386	2043	1286	2028	1244	2100	1388	42	6.5
2	1000 + 450	2100	1450	1426-1486	2043	1386	2028	1344	2100	1488		
3	1100 + 450	2100	1550	1526-1586	2043	1486	2028	1444	2100	1588		
4	900 + 450	2350	1350	1326-1386	2293	1286	2278	1244	2350	1388		
5	1000 + 450	2350	1450	1426-1486	2293	1386	2278	1344	2350	1488		
6	1100 + 450	2350	1550	1526-1586	2293	1486	2278	1444	2350	1588		
7	1200 + 450	2350	1650	1626-1686	2293	1586	2278	1544	2350	1688		







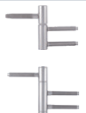

WESMARC IS DIFFERENT FROM THE REST

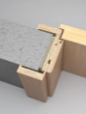
WESMARC emerges as the unrivaled leader in the Indian door industry, surpassing competitors with unmatched technological advancements, exceptional product quality, and unrivaled door aesthetics.

FEATURES	IMAGE	WESMARC DOORS	MARKET DOORS	FEATURE IMPORTANCE/IMPACT
DOOR				
3 SIDE REBATED		Wesmarc Rebated door offers a seamless appearance with enhanced aesthetics.	Straight door	1. Improved Sound Insulation 2. Enhanced Thermal Efficiency 3. Blocks external light
DOOR THICKNESS		Setting the global standard, our 45 mm and 42 mm thick doors deliver unmatched strength and durability.	30 to 36 mm thick	1. Increased Security 2. Enhanced Durability 3. Improved Sound Insulation
STILE & RAIL WIDTH		The 75 mm wide stile and rail inside door offers style and strength in one.	± 50 mm	1. Improved Functionality 2. Longevity 3. Improved Durability
INFILL		Wesmarc has both Tubular Core or Solid core infill for versatile, reliable doors.	Tubular core /w Honeycomb	1. High strength-to-weight ratio 2. Stiffness and stability 3. Thermal insulation
DECK		Wesmarc provides doors with a versatile selection of 4mm or 5.5mm deck options to suit your specific needs.	± 3 mm / undisclosed	1. Enhanced durability 2. Improved Sound Insulation 3. Better thermal insulation
CPL VENEER		Italy and Germany import durable, easy-to-clean CPL veneer, costlier than natural veneer, but its longevity and stunning aesthetics justify the expense.	Veneers, PU, To be confirmed by client	1. Durability & Protection 2. Easy Maintenance 3. Aesthetics
EDGE BAND		Our 4-side edge band doors offer a seamless and refined appearance, ensuring a professional finish for any space.	4 side edge band	1. Protection 2. Aesthetics 3. Durability
GLUE FOR LAMINATION		Utilizing PUR glue for veneer lamination ensures a strong and reliable bond, resulting in a beautiful and long-lasting finish for your project.	D3 / Regular white glue	1. Adhesion 2. Moisture Resistance 3. Longevity and Durability
GLUE FOR EDGE BANDING		With PUR glue , our door edge banding achieves a strong and seamless bond, enhancing durability and aesthetics.	D3 / Regular white glue/Hot melt	1. Secure Adhesion 2. Protection and Sealing 3. Enhanced Aesthetics

HARDWARES FOR DOOR



LOCK		Factory fitted Mortise lock and has been rated according to EN standards.	The standard offer does not include this particular item.	1. Security Assurance 2. Reliable Performance 3. Compliance with Regulations
CYLINDER		Euro profile cylinder with 5 ultra-security keys, Computer cut. Tested for 200,000 cycles for durability and reliability.	The standard offer does not include this particular item.	1. Enhanced Security 2. Reliable Performance 3. Peace of Mind
HINGE		German imported 2 and 3 element hinges with adjustable feature for precise door alignment and versatile installation options.	Butterfly hinges have limitations in terms of 180° opening, adjustability and load-bearing capacity.	1. 180-degree opening 2. Load-Bearing Capacity 3. Adjustability
SECURITY LOCKING BOLT ENTRANCE		3 Security locking bolts , Intelligent solution to additionally secure entrance door ways.	Not possible	1. Enhanced Security 2. Deterrent to Intruders 3. Peace of Mind

FEATURES	IMAGE	WESMARC DOORS	MARKET DOORS	FEATURE IMPORTANCE/IMPACT
FRAME				
WALL WRAP FRAME		Wraps the full thickness of wall for a seamless look, and enhanced structural support.	The block frame may not warp or cover the whole wall thickness.	1. Superior Structural Integrity 2. Seamless Wall Integration 3. Enhanced Aesthetics
ADJUSTABLE FRAME		The adjustable frame with an additional 20mm on the wall thickness offers versatility in door installation	Not possible	1. Versatile size Compatibility 2. Easy installation 3. Improved Aesthetics
WALL TOLERANCES		Both side extension/Ledge= +30/-50mm One side extension/Ledge= +30/-20mm	± 5mm or Not possible	1. Easy installation 2. Smoother installation 3. Improved longevity
ENG. WOOD ARCHITRAVE 60MM		Wesmarc offers a premium finish to their doors with incorporating a 60mm engineered wood frame architrave .	± 30mm wide architrave	1. Increased Structural Support 2. Concealment of Gaps 3. Enhanced Aesthetic Appeal
CPL VENEER WRAPPED		CPL veneer imported from Italy and Germany	Veneers, PU , To be confirmed by client	1. Enhanced Visual Appeal 2. Durability and Resilience 3. Easy Maintenance
BOTTOM SIDE WATER SEALANT		Wesmarc doors feature a bottom-side water sealant on the door frame, providing moisture protection .	Bottom-side water sealant on the door frame.	1. Moisture Protection 2. Enhanced Durability 3. Extended Lifespan
45 DEGREE MITRE JOINT		Wesmarc door frames feature 45-degree miter joints for the frame corners	traditional market door frames often utilize butt joints	1. Enhanced Aesthetics 2. Improved Structural Integrity 3. Reduced Visible Gaps
GLUE FOR WRAPPING		PUR Glue for Veneer wrapping	D3 / Regular white glue	1. Adhesion 2. Moisture Resistance 3. Longevity and Durability

HARDWARES FOR FRAME

STRIKER PLATE		Wesmarc has Rounded Striker Plates with Color Matched Plastic Masking Cap	Typically have straight plates that lack color matching capabilities .	1. Reinforced security 2. Privacy enhancement 3. Extended Door Lifespan
CO-EXTRUDED ACOUSTIC SEAL		Wesmarc's Co-extruded Acoustic Seal with Color Variation and Built-in Grips/Anchors .	No seal	1. Superior sound insulation 2. Gentle, soft closing. 3. Aesthetic Integration
HINGE BRACKET		Wesmarc has Hinge Bracket for Holding and Adjusting Hinges	Lack a dedicated bracket , making it challenging to align the door .	1. Flexibility in Alignment 2. Simplified Installation 3. Improved Door Functionality

INSTALLATION

HIDDEN ANCHOR FASTENERS		Wesmarc door systems feature a superior anchoring technology that is hidden inside the back of the frame, ensuring a clean and seamless appearance.	Anchor bolts that are visible .	1. Enhanced Security 2. Aesthetically Pleasing 3. Enhanced Security
ALL FIXING CLAMPS AND FIXTURES		Wesmarc's inclusion of all necessary fixtures in their offer can provide added value and peace of mind for customers.	Installers to source standard fixtures locally.	1. Convenience and Compatibility 2. Consistency and Quality Control 3. Time and Cost Considerations
EASY INSTALLATION		Wesmarc doors with factory-fitted hardware featuring modern technology. Simply installed by 2 hands in 60 min.	Challenging & Time-consuming	1. Time Efficiency 2. Simplified Installation 3. Enhanced Functionality

DESIGN INSPIRATION

We think doors are far more than just a means to separate one space from another. We think of it as a key part of the interior decor.

So, we've made the process of choosing doors, a joyful activity. Here are some tips to help you choose the doors that add to the character and look of your living space.

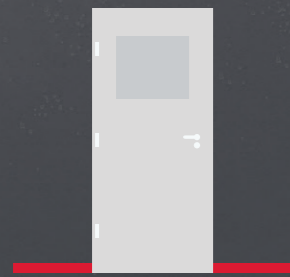

FIT IT TO SKIRTING BOARDS

Doors can be accented beautifully by the skirting boards that line the wall. So, observe the colour, height, finish, and style of the boards and choose your doors and frames accordingly.

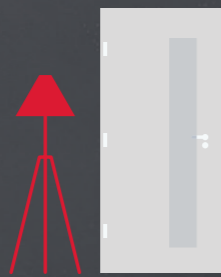

FIT IT TO DETAILS

When it comes to styling a room, the devil is in the details. So take your cues from the detailing of your room and choose a door and frame that works well to highlight them.

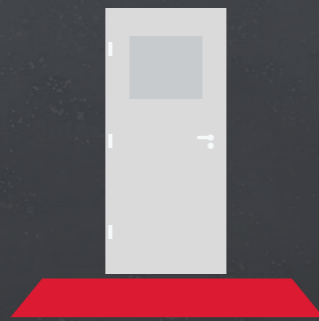

FIT IT TO COLOURS

Another great anchor point for the design of a space is the floor or wall colour. Match the doors and frames to the shade of the floor or wall, or, go the opposite way for a contrasting colour palette.

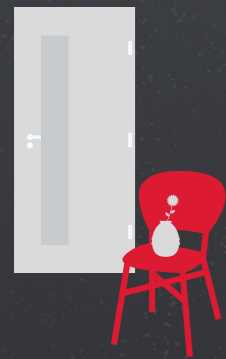

FIT IT TO FURNITURE

The character of the room is underscored by its furniture, and doors are a big part of it. Match the finish of your doors and frames to complement the structure and shade of your furniture.

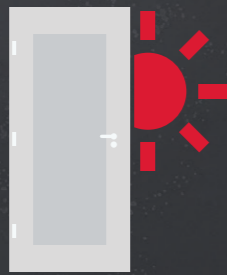

FIT IT TO LIGHTING

The beauty of a room really comes out when soaked in natural light. And when there is little daylight access, the room can be lit up thanks to glass doors.

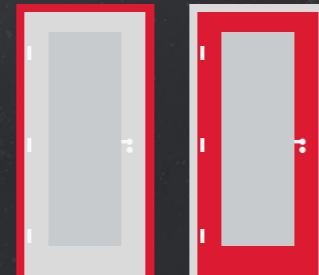

FIT IT TO STYLE

There is no wrong way of styling an apartment. They can be minimal or loud, while still having a distinct style. So make sure you choose the doors and frames that play along with your style.

LEFT OR RIGHT?

An aspect of buying a door that is often overlooked until the last minute is its orientation and direction of opening. In other words, do you need a left or right door?

How do you determine whether the door is a left or a right door?



1. Locate which side of the frame the hinge is on.



2. Stand between the frames facing directly towards the hinge.



3. If the door opens towards your Left, it's a left arm stretched out door.

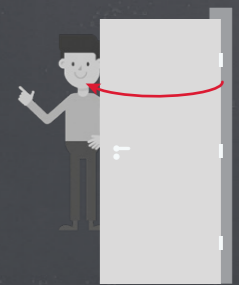

4. If the door opens towards your Right, it's a right arm stretched out door.



Look from one side.



Look from the otherside.

FLUSHED OR REBATED?

CREATING FIRST IMPRESSIONS

MATERIAL PALETTE HIGH QUALITY CPL VENEERS

Not many things are as unpredictable as the Indian weather and usage patterns.

A vast geography, leading to vast differences in weather conditions and an equally vast difference in how the doors are used across, demanded a range of materials that stand resolute. So, we combined a consistently high-level of functionality with elegance.



MATERIAL PALETTE



Dark Oak



Stained Walnut



Natural Walnut



Natural Eucalyptus



Natural Oak



White Ash

Abrasion



Doors and frames are exposed to abrasion every day. So, naturally, the veneer that covers it must withstand the energy of our children and the scratches of our pets as they wait for us. So, we use only high quality CPL veneers, which is incomparably much more abrasion-resistant compared to natural veneer.

Humidity



Humid weather is just as unpleasant to our doors as it could be, to us. They lead to a swelling of the doors, causing them to drag on the floor or against the frame. The first line of defence against humidity is the outer veneer. So, for a superior stability and protection, we only use CPL veneers that do not absorb any moisture.

Cleaning Products



The usage of doors across our country involves regular cleaning with wet and soapy cloths. These factors, over time, naturally have an ill affect on the durability of the door surface. Which is why, WESMARC doors are designed such that they don't need to be cleaned nearly as often.

Diffused Sunlight



There aren't many things harsher on a door than an Indian summer. So much so, that discolouration of doors is commonplace. But that didn't deter us from testing all our doors for their reaction to diffused daylight. And we are proud to say, that they achieve high colour stability throughout their lifespan.



Dark Oak

Stained Walnut



Natural Walnut

Natural Eucalyptus

INSTALLATION MADE EASY



STEP 1

Glue and assemble the factory finished vertical elements of the frame to the horizontal with the provided screw and clamp assembly.

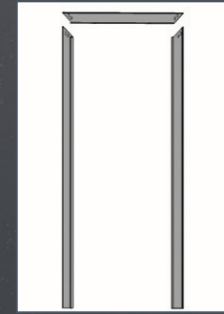

STEP 4

Now, for the reverse side, the factory finished architrave is easily assembled the same way using glue, screws and clamps. The result is a firmly jointed & perfectly finished 45° edge.

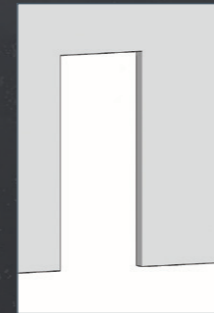

STEP 2

Our unique hinges lock to the architrave by just tightening its screw. Then the entire frame assembly is placed within the wall opening and aligned.

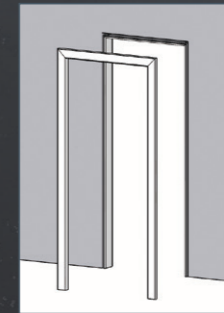

STEP 5

This is then simply push fixed with some glue into the slotted groove in the main frame.

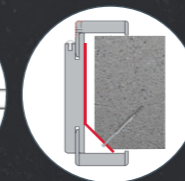
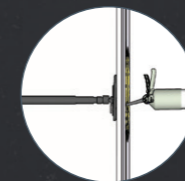

STEP 3

Stability bars are clamped on the frame & wall, following fix the hidden anchor fasteners and using a gun, expanding PU foam to cover the gap between the frame & the wall.



STEP 6

Finally, the factory finished door leaf with its pre-installed lock and hinge is literally just hung onto the hinge on the frame. Millimeter alignment precision can be achieved in 3D by a simple adjustment of the hinge screw using just a screwdriver.



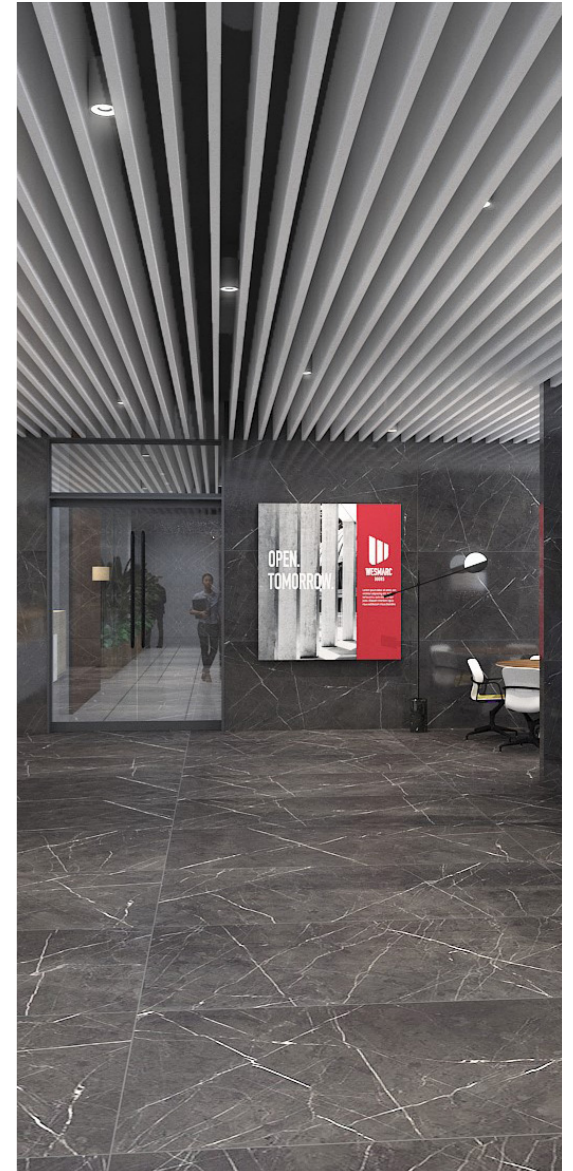



WESMARC DOORS

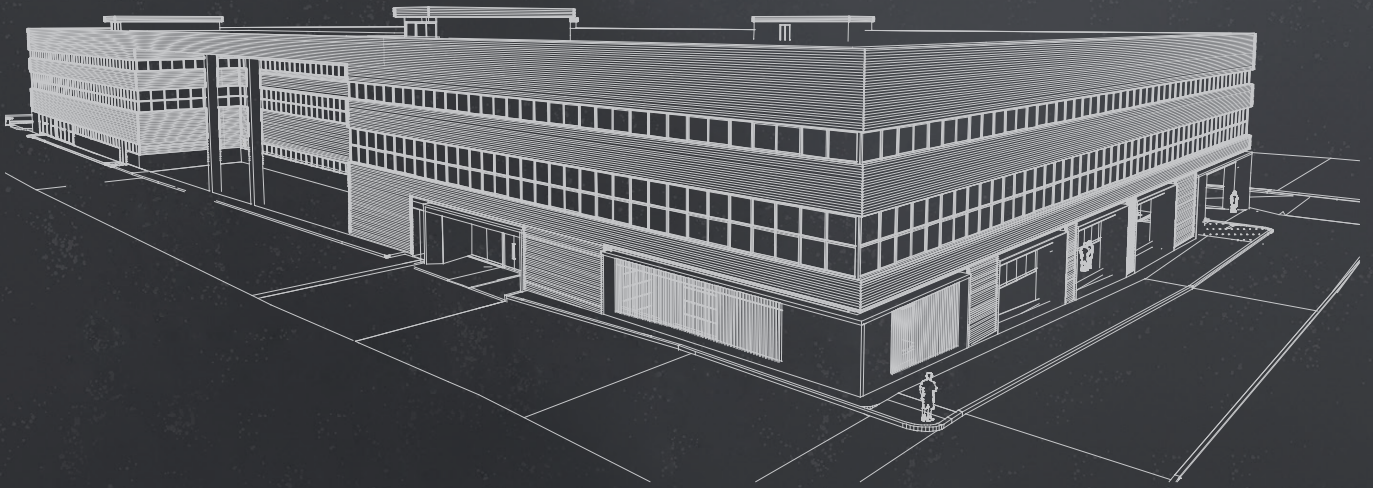

**INDIA'S MOST
MODERN & LARGEST
DOOR & FRAME MANUFACTURING**

VISIT OUR FACTORY

Wesmarc Doors Technik Pvt Ltd

#61/B1, 61/B2 & 61/C

Bommasandra Industrial Area, Bengaluru- 99

Tel: 9880918981. E-Mail: namaste@wesmarcdoors.com

VISIT OUR DELIGHT STUDIO

Wesmarc House

#2023, 2nd Floor, 100 Ft Rd

Indiranagar, Bangalore-08

Tel: 9880918981. E-Mail: namaste@wesmarcdoors.com